

— **LEAF**
OBLIQUE collection_2021



1-
3

— DATA SHEET

LEAF is a wall-mounted washbasin made with a 19 mm thick bilaminated Poplar blockboard or Canaletto Walnut/Oak blockboard structure, with drawer fronts in blockboard of the available essences or in matt white lacquered Tanganyika Walnut blockboard.

The structure has a predisposition for wall mounting with a system of metal brackets, supplied in the accessory kit, which allow the necessary leveling adjustments, while the two drawers are equipped with metal guides with a soft control full extension system.

The top and the integrated tray, of the same material, are made with the aid of CNC machines that guarantee maximum cutting precision and are chemically treated with water-based water-oil repellents (ecofriendly). The chromed 'click click' type drain with cover in the same material as the washbasin is included.

Since these are handcrafted products, the images of the materials used are indicative, photos of the materials actually selected will be provided at the time of the order.



— **FINISHES**

• **MARBLES:**

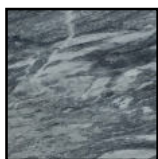

Bardiglio

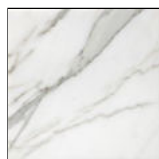

Calacatta



Statuario



Lavica

• **WOODS:**



Noce Canaletto



Rovere

— **TECHNICAL INFORMATION**

- TOP + BATHTUB_20 mm thick marble with natural honed finish e water-based water-oil repellent treatment (ecofriendly).
- STRUCTURE_matt white bilaminated poplar blockboard thickness 19 mm/ Blockboard Canaletto Walnut or Oak thickness 19 mm.
- DRAWERS_blockboard Canaletto Walnut or Oak thickness 19 mm varnished with water-based polymers/lacquered Tanganyika walnut thickness mm 19 in white colour with matt finish and treatment with anti-yellowing polyurethane polymers.

2-
3

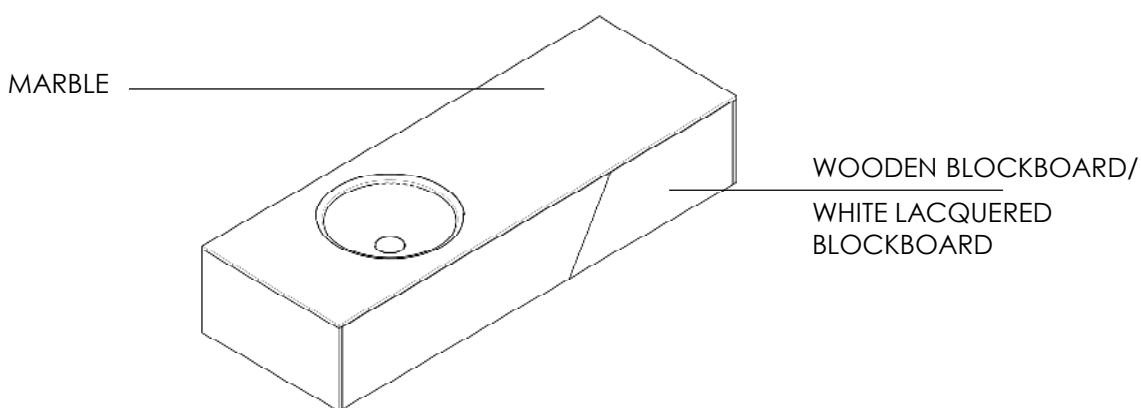



LEAF
Oblique
Collection
2021

— DIMENSIONS

PIANTA

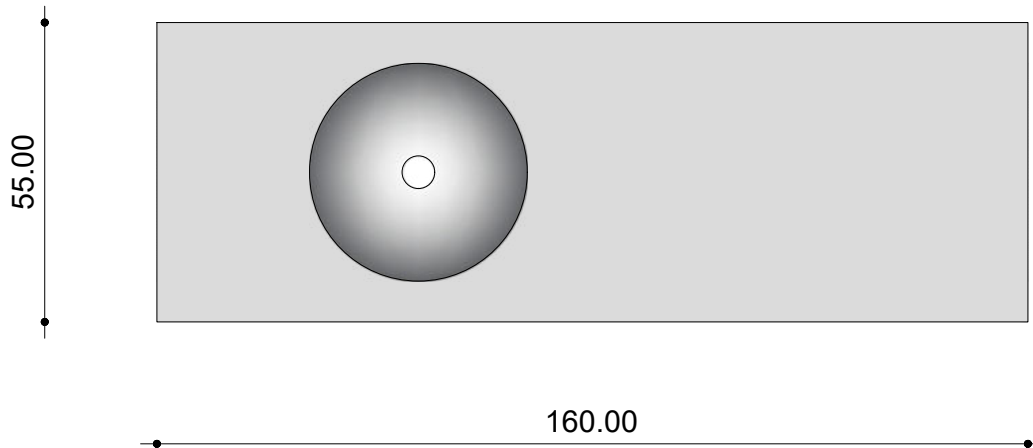

FRONT

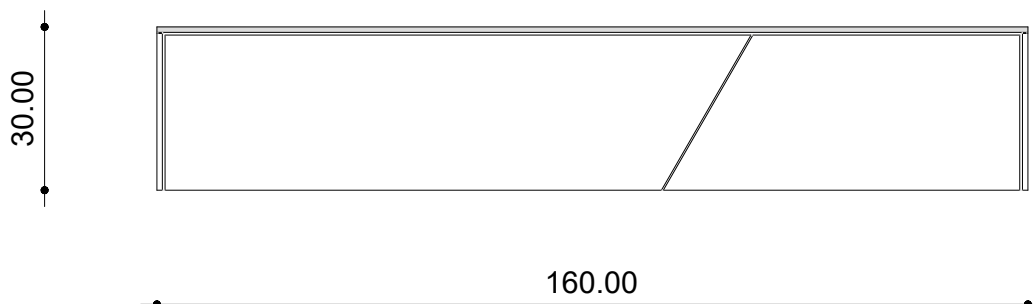

LATERAL SX

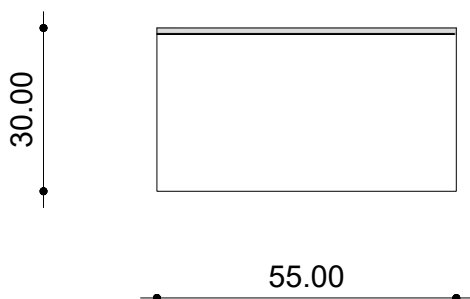

LATERAL DX

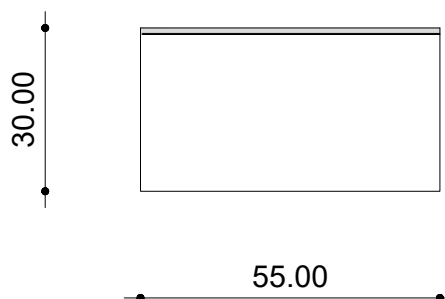

— DATA SHEET

Dimensions expressed in centimeters. The company reserves the right to make changes to the models without notice. The information reported here is based on the latest data published in the price list.